

# Precision Sensor News

This issue of the Precision Sensor News is dedicated to Dissolved Oxygen measurements. The topics we will cover in this issue are: testing, routine maintenance, sensor rebuilding and sensor selection.

The Dissolved Oxygen test station, shown below in Figure 1, is an ideal tool for the quick and reliable identification of D.O. sensor malfunctions.

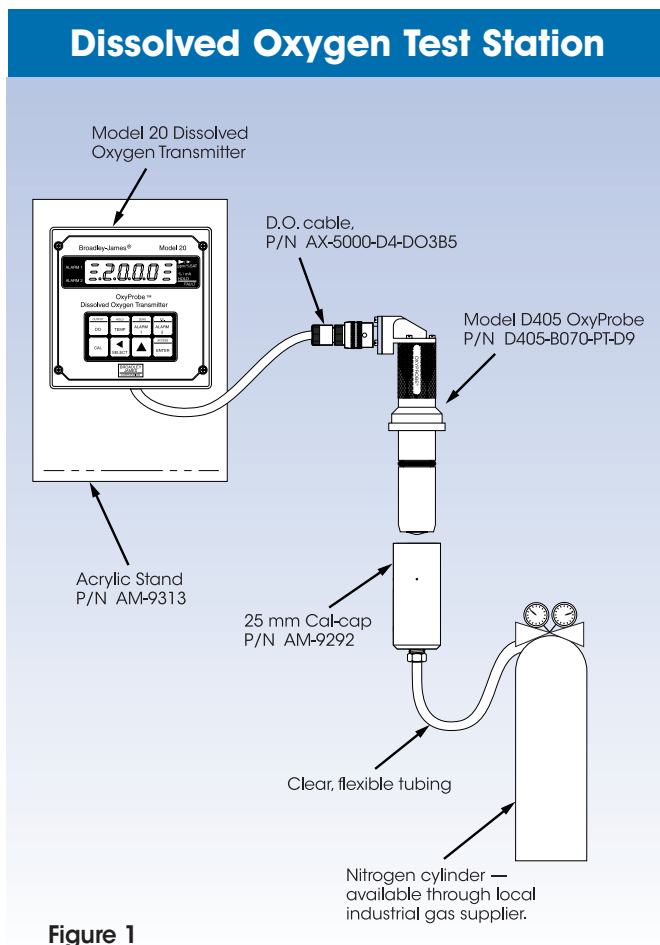

Figure 1

Our in-house training seminars and hands-on workshops address the issues of Dissolved Oxygen precision with practical tips and procedures.

## Troubleshooting

One of the more useful diagnostic indicators of sensor "health" is its response characteristics. Plotting the data, time vs. % air saturation, should yield curves similar to those in Figure 2 below. Displayed on the graph are three of the most common curves. Plot "A" is a normal curve. Plot "B" shows a very quick response to an "elevated zero" which might be caused by a cracked cathode. Plot "C" shows a very sluggish response to zero. This might be indicative of a contaminated membrane and/or anode/cathode surfaces. Properly recorded data will provide useful information for troubleshooting and failure analysis.

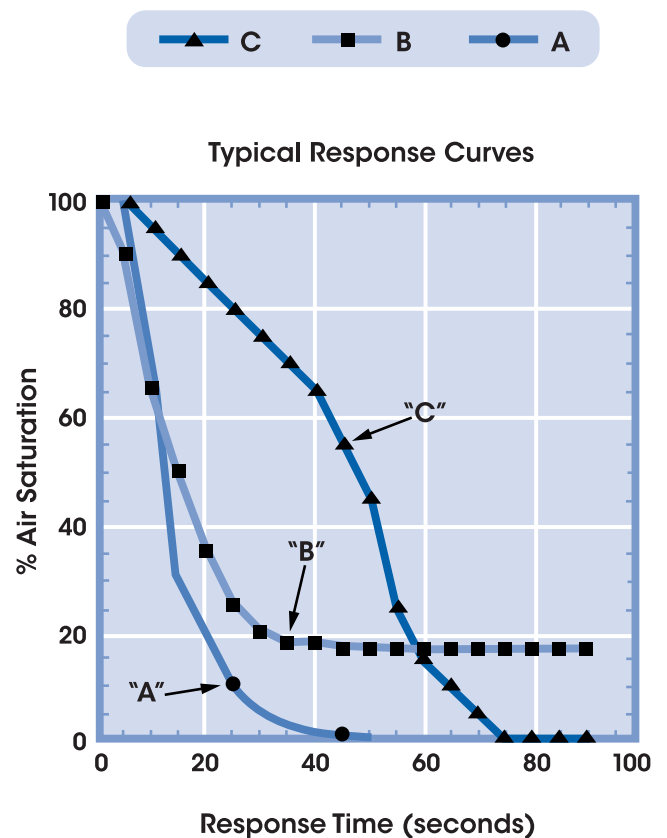
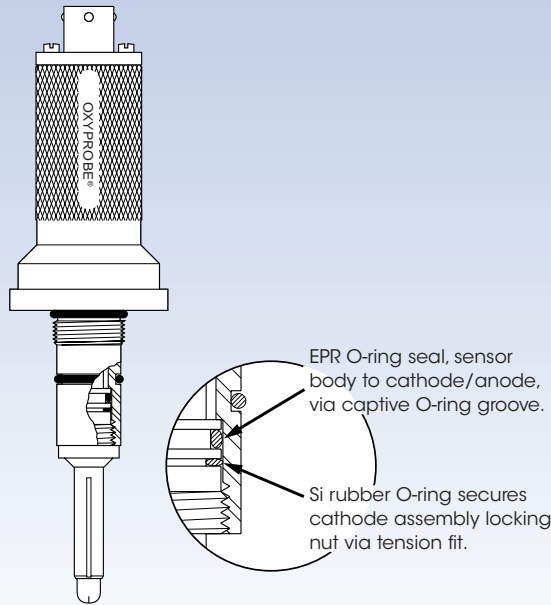

Figure 2

## Advanced O-ring Seal Design

To optimize the OxyProbe's performance in demanding applications we've incorporated a double O-ring design. This design, using a captive O-ring groove, ensures the O-ring's sealing properties.



### What's the sensor really measuring?

The current measured by the polarographic Dissolved Oxygen sensor is directly proportional to the partial pressure of oxygen. The figure below illustrates the sensor's output resulting from pressure changes. The critical distinction is that in both examples the Oxygen partial pressure is fixed at 21%, however the total pressure has changed resulting in both an altered sensor output and hence an altered reading.

### Total Pressure Versus % Oxygen

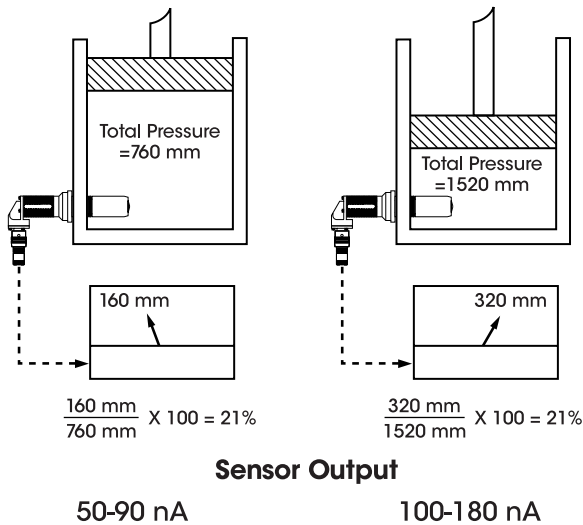

## Rebuilding OxyProbe Dissolved Oxygen Sensors

Dissolved Oxygen sensor servicing sometimes seems a bit mysterious but the modular design of the OxyProbe Dissolved Oxygen sensors eliminates the guesswork.

Inside the sensor's sleek stainless steel body is the secret to the success of the OxyProbe. The dozen or so components, which make up the OxyProbe, require no special instruments or procedures for re-assembly. "For such a sophisticated sensor it's as close to plug and play as you can get", remarked one customer.

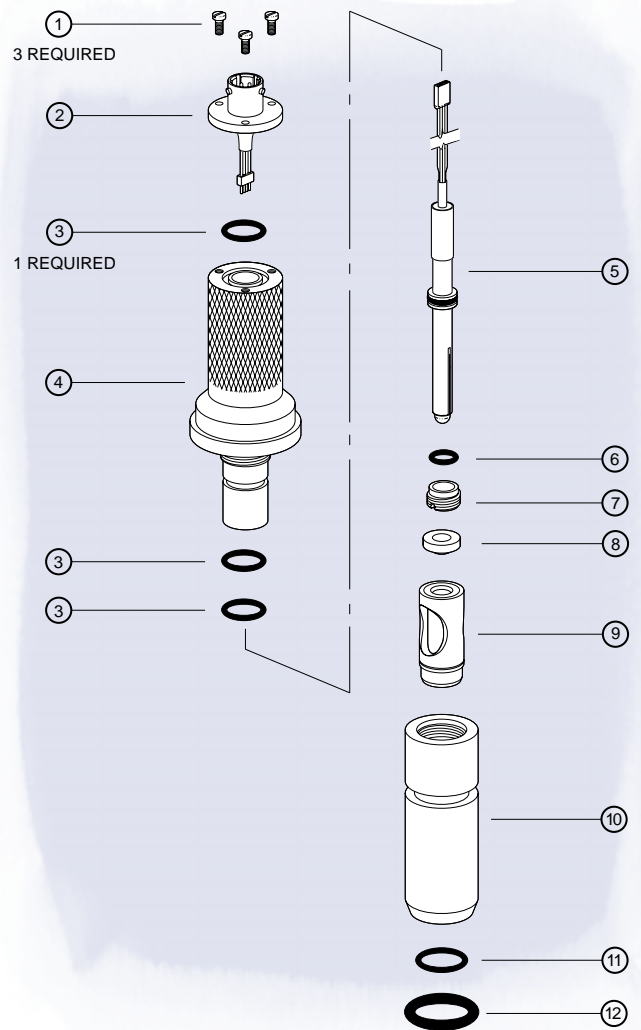

1. Connector screws
2. 4 pin connector assembly
3. O-ring
4. D.O. sensor body
5. Anode/cathode assembly
6. O-ring

7. Retainer nut
8. Conical gasket
9. Membrane cartridge
10. Sleeve
11. O-ring
12. O-ring

## Ensuring Reliable D.O. Measurements

The cathode, responsible for the reduction of the oxygen molecules, is a precision manufactured assembly of Platinum and glass. The cathode surface has been fine tuned to ensure reliable D.O. measurements. Any obstruction or damage of the surface will, most likely, effect the measurement.

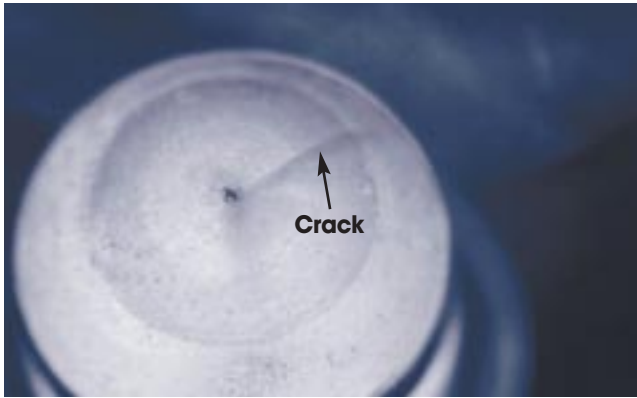

Cracked Cathode

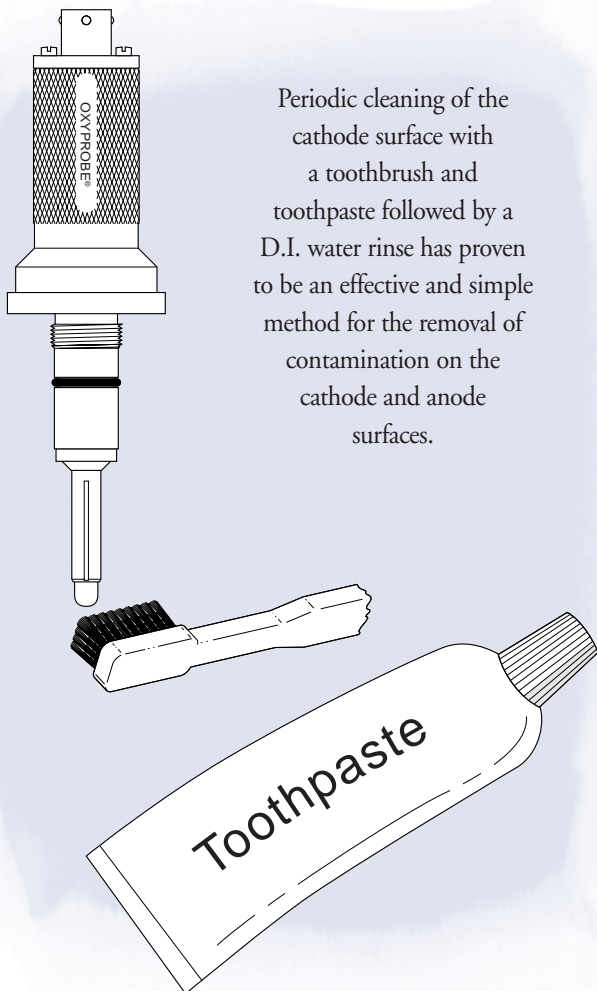

Periodic cleaning of the cathode surface with a toothbrush and toothpaste followed by a D.I. water rinse has proven to be an effective and simple method for the removal of contamination on the cathode and anode surfaces.

## Top 10 List

Probable causes for D.O. sensor malfunctions:

1. Punctured membrane
2. Torn or ripped membrane
3. Dirty cathode surface
4. Dirty or fouled anode surface
5. Damaged O-ring
6. Missing O-ring
7. Damaged cathode
8. Dirty membrane
9. Corroded connector
10. Electrolyte level too low

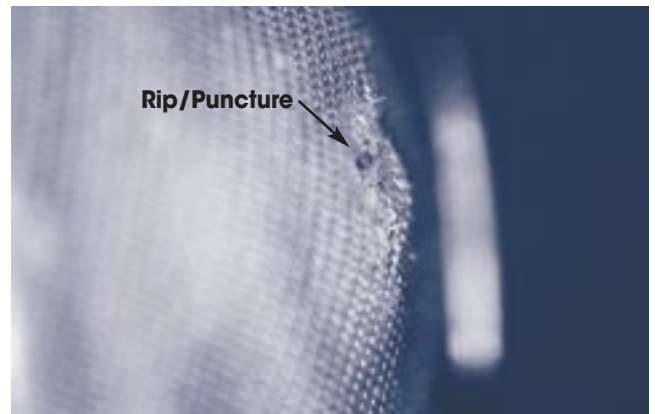

Damaged Membrane

For immediate technical assistance call our Corporate Sales Office at 1-800-288-2833.

**Broadley<sup>®</sup>  
James**

Our U.S. offices now accept corporate Visa and Mastercard charge cards for your purchasing convenience.